

# MTRFG-1.5" RECESSED FLANGED MODULAR TRACK

A 1.5" recessed 24V low voltage flanged ceiling slot system designed to fit together like building blocks. The system is perfect for minimalist spaces with a variety of lighting elements. Linear and multi-celled modules provide general ambient and task lighting, where spot lights, pendants and color-changing RGB+W modules provide accent lighting to create drama within any space. LED modules available to achieve spotlighting or general downlighting.

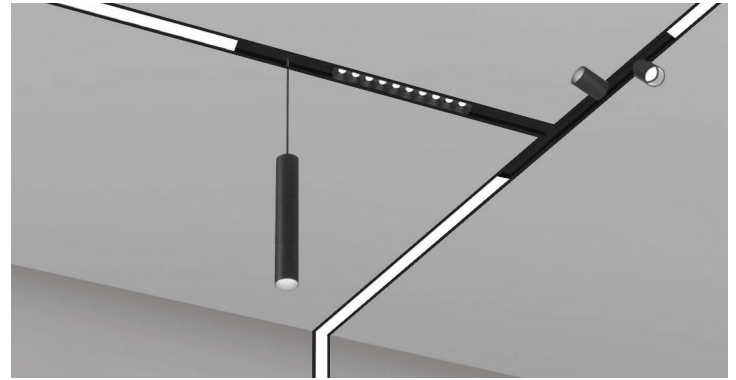

## TRACK ORDERING - Example: MTRFG-48B-RMT-TR

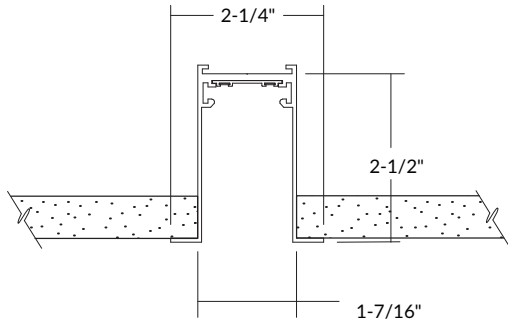

### MTRFG

Mounting Track	Length	Finish	Power Feed Method		
<b>Length</b>	<b>Finish</b>	<b>Power Feed Method</b>			
2' Track	<b>-24</b>	Black	<b>B</b>	End Cap Powered (Remote)	<b>-RMT-EC61</b>
4' Track	<b>-48</b>	White	<b>W</b>	Adjacent Track Powered Adjustable (Remote)	<b>-RMT-TR</b>
6' Track	<b>-72</b>	Custom	<b>CSTM</b>	Top Powered (Remote)	<b>-RMT-TF61</b>
8' Track	<b>-96</b>			120V/277V 96W (On-Board Integral Power Supply)	<b>-JBX-96UE</b>
Custom	<b>-XX</b>				

## POWER FEED METHODS (Explained)

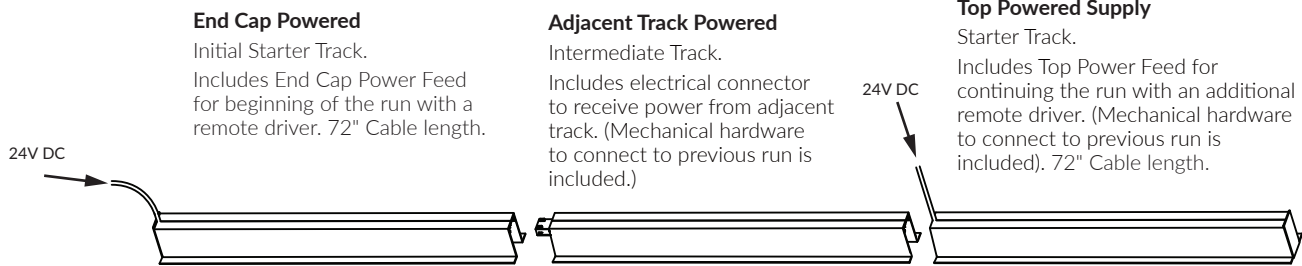

## AVAILABLE CORNERS/END CAP

Corners are available for 90° turns in the same plane or transitioning from ceiling to wall. Corners feed a module in both directions without the need of new power feed.

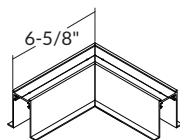

**MP943-RFG**  
"L" Corner  
(Ceiling to Ceiling)

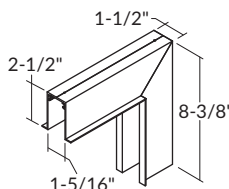

**MP944-RFG**  
Vertical Corner  
(Wall to Wall)

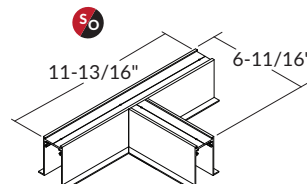

**MP905-RFG**  
T-Connector

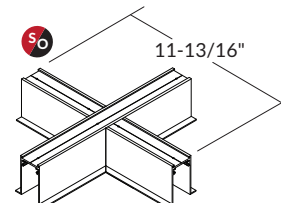

**MP946-RFG**  
X-Connector

Special order item. Extended lead time.

## SPECIFICATION

### Applications

Minimalistic architectural extruded lighting channel with a flanged recessed finish. Mounts to ceiling or wall surfaces. Can be equipped with a wide range of LED modules.

White version gives depth to ceiling planes while black finish provides a visible separation above sight level.

Designed for low to medium ceiling heights in retail, hospitality, commercial and high-end residential applications that benefit from zero sight line linearity and symmetry in modern interior lighting designs.

### Extrusion Housing

Recessed Flanged inserted during post-construction of ceiling/wall.

### Mounting

Flanged mounting includes a notched flange for installation in drywall or plaster ceilings. Additional beam support being ceiling/wall material recommended.

### Accessories

All extrusions shipped with specified power feed connector, extruded conductor cover. End of line end cap, corners and other accessories not included.

### LED Details

Color Temperature - OSRAM or Cree® LEDs binned to 3-step MacAdam ellipses within the ANSI C78 377A standard for color temperature and chromaticity ranges light binning allowance. 90 CRI standard.

Lumen Maintenance - Minimum 50,000 hours L70 life based on ANSI TM-21 calculations from LM80 standardized test results.

### Thermal Management

Effective thermal dissipation facilitated by integral extruded aluminum heat sink design for maximum heat rejection to provide long LED life.

### Certifications and Listings

ETL/cETL listed to UL1598 and UL8750. Suitable for dry and damp locations. NYC approved: Calendar #41937. MM2, MM2D, and MM2P modules are California Title 24/JA8 approved. Declare Listed and Red List Free.



ModuLED Stealth carries the Declare Label identifying our Stealth track system as Red List Free per review by the International Living Future Institute acknowledging sustainable and transparent manufacturing practices. This certification reports on the ecological impact the product will have over its lifecycle as well as end of life taking into account materials, shipping, and recyclability.

For further information, please visit:

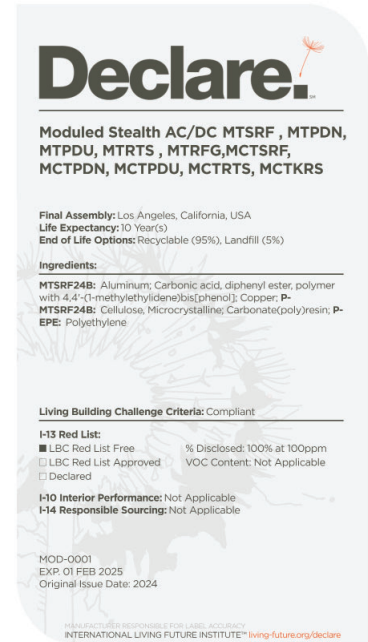

### Caution

Power supply must be grounded in accordance with national, state and/or local electrical codes. Failure to do so may result in serious personal injury.

### Warranty

Covered by a 5 Year Warranty to be free of defects in materials and craftsmanship. Recommended for applications where ambient temperatures do not exceed 35°C. Installations exceeding this temperature will result in reduced LED lamp life and a voided warranty.

Cree® is a registered trademark of Cree, Inc.

## ILLUMINATED MODULES

### MM1 Linear Diffused (Static White)

Ordering Example: MM124B-L08-T27

	Length	Finish	
• Pixel free illumination	1' <b>MM112</b>	Black	<b>B</b>
• Two lumen options	2' <b>MM124</b>	White	<b>W</b>
• Warm dimming option	3' <b>MM136</b>		
• 500lm-8800lm	4' <b>MM148</b>		
	6' <b>MM172</b>		
	8' <b>MM196</b>		

Lumens (Nominal Delivered)	
500lm (9W) per foot	<b>Blank</b>
1100lm (12W) per Foot	<b>-L08</b>

CCT	
2700K, 90 CRI	<b>-T27</b>
3000K, 90 CRI	<b>-T30</b>
3500K, 90 CRI	<b>-T35</b>
4000K, 90 CRI	<b>-T40</b>
Warm Dimming	<b>-TWD</b>
1850K-3000K	

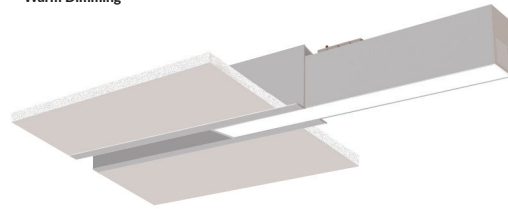
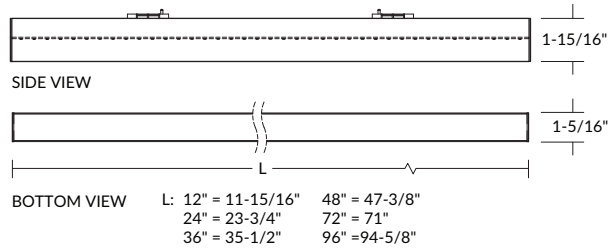

### MM1 Linear Diffused (RGB +W)

Ordering Example: MM124B-RGBW-BT

	Length	Finish	
• Bluetooth or DMX compatability	1' <b>MM112</b>	Black	<b>B</b>
• 1 million plus colors available	2' <b>MM124</b>	White	<b>W</b>
• Achieve Pastel colors	3' <b>MM136</b>		
	4' <b>MM148</b>		
	6' <b>MM172</b>		
	8' <b>MM196</b>		

Lumens (Nominal Delivered)	
350lm (9W) per foot	<b>Blank</b>
700lm (15W) per foot	<b>-L08</b>

Dimming	
Basic Bluetooth Control	<b>-RGBW-BT</b>
Hardwire PWM Dimming	<b>-RGBW-PWM</b>

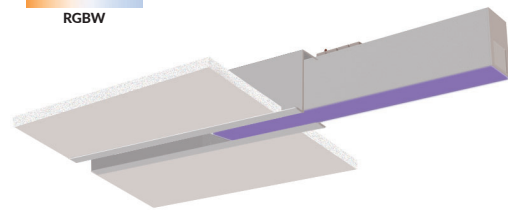
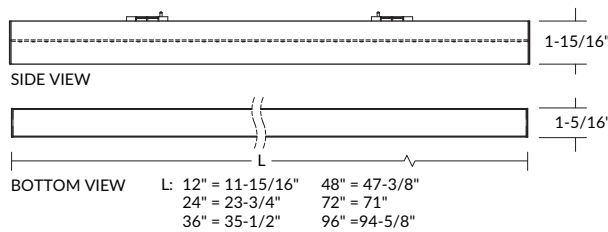

**NOTE: MM1 Linear Diffused is not compatible with DALI.**

## ILLUMINATED MODULES

### MM2 Downlight Directed (Louvered)

Ordering Example: MM206B-B40-T30

	Length	Finish	Beam Spread	CCT
• Multiple beam spread options	6", 1000lm (11W) <b>MM206</b>	Black <b>B</b>	15° Narrow Spot <b>-B15</b>	2700K, 90 CRI <b>-T27</b>
• Glare free illumination	12", 2000lm (22W) <b>MM212</b>	White <b>W</b>	40° Flood <b>-B40</b>	3000K, 90 CRI <b>-T30</b>
• Minimal 1" square	18", 3000lm (33W) <b>MM218</b>		60° Wide Flood <b>-B60</b>	3500K, 90 CRI <b>-T35</b>
• California Title 24/JA8 Approved			30° x 60° Asymmetric <b>-B3060</b>	4000K, 90 CRI <b>-T40</b>

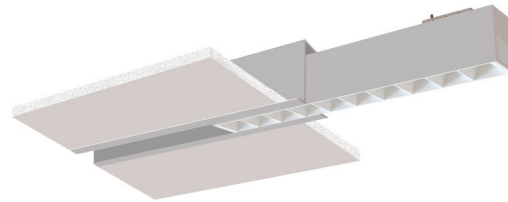
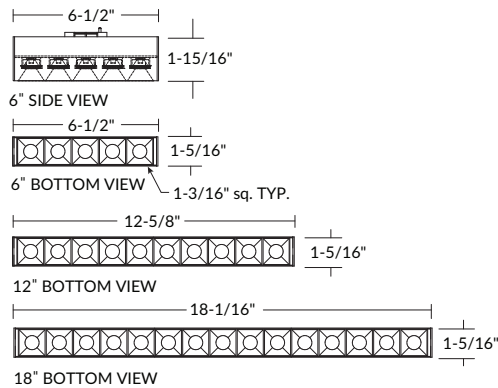

### MM2D Deco-Line Crystal Pendant

Ordering Example: MM2D06B-B40-T30

	Length	Finish	Beam Spread	CCT
• Added decorative touch	6", 1000lm (11W) <b>MM2D06</b>	Black <b>B</b>	15° Narrow Spot <b>-B15</b>	2700K, 90 CRI <b>-T27</b>
• Client provided crystal options	12", 2000lm (22W) <b>MM2D12</b>	White <b>W</b>	40° Flood <b>-B40</b>	3000K, 90 CRI <b>-T30</b>
• California Title 24/JA8 Approved	18", 3000lm (33W) <b>MM2D18</b>		60° Wide Flood <b>-B60</b>	3500K, 90 CRI <b>-T35</b>
			30° x 60° Asymmetric <b>-B3060</b>	4000K, 90 CRI <b>-T40</b>

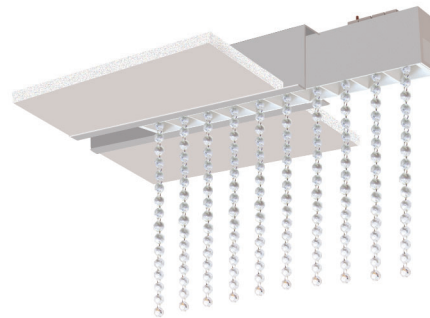
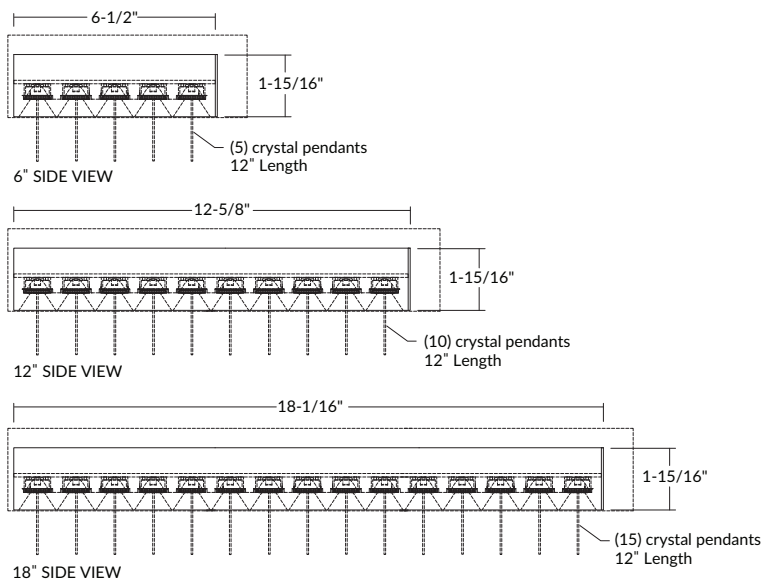

## ILLUMINATED MODULES

### MM8 2-Spot Recessed Downlight

- Spot, and Flood Beam Spreads
- 500lm (5W)

Finish	Beam Spread	CCT
Black <b>B</b>	20° Spot <b>-B20</b>	2700K, 90 CRI <b>-T27</b>
White <b>W</b>	40° Flood <b>-B40</b>	3000K, 90 CRI <b>-T30</b>
		3500K, 90 CRI <b>-T35</b>
		4000K, 90 CRI <b>-T40</b>

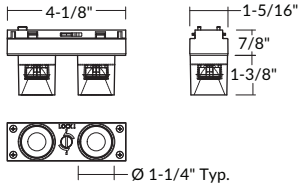

Ordering Example: MM8B-B40-T27

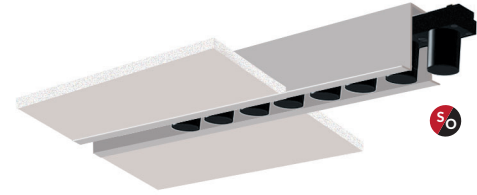

### MM8J 2-Spot Adjustable Recessed Downlight

- Two independently adjustable LEDs
- Multiple Beam Spreads
- 500lm (5W)

Finish	Beam Spread	CCT
Black <b>B</b>	20° Spot <b>-B20</b>	2700K, 90 CRI <b>-T27</b>
White <b>W</b>	40° Flood <b>-B40</b>	3000K, 90 CRI <b>-T30</b>
	30° x 60° <b>-B3060</b>	3500K, 90 CRI <b>-T35</b>
	Asymmetric	4000K, 90 CRI <b>-T40</b>

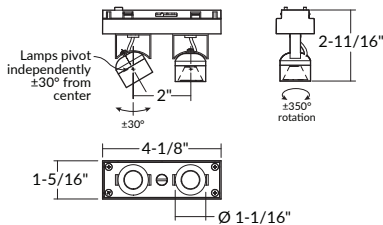

Ordering Example: MM8JB-B20-T27

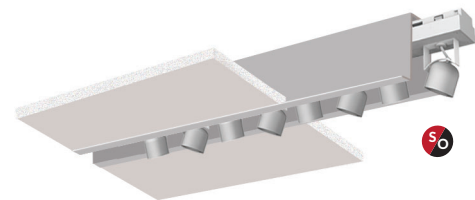

Special order item. Extended lead time.

## ILLUMINATED MODULES

### MM2J Adjustable Wall Wash

Ordering Example: MM2JB-B40-T30

- Adjustable wall wash tilts from 0° to 90°
- Multiple beam spread options
- Minimal 1" square

Length
6", 1000lm (11W) <b>MM2J</b>

Finish
Black <b>B</b>
White <b>W</b>

Beam Spread
15° Narrow Spot <b>-B15</b>
40° Flood <b>-B40</b>
60° Wide Flood <b>-B60</b>
30° x 60° Asymmetric <b>-B3060</b>

CCT
2700K, 90 CRI <b>-T27</b>
3000K, 90 CRI <b>-T30</b>
3500K, 90 CRI <b>-T35</b>
4000K, 90 CRI <b>-T40</b>

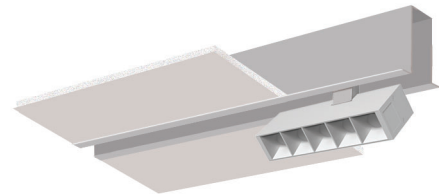
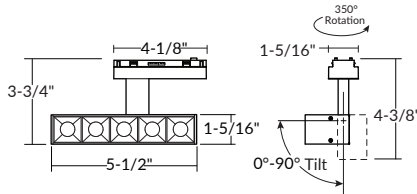

### MM3 Adjustable Spot

Ordering Example: MM307B-B20-T27

- Regressed LED optic for low glare
- Fully Adjustable

Lumens
650lm (9W) <b>MM307</b>
1500lm (15W) <b>MM315</b>

Finish
Black <b>B</b>
White <b>W</b>

Beam Spread
10° Narrow Spot <b>-B10</b>
20° Spot <b>-B20</b>
40° Flood <b>-B40</b>
30° x 60° Asymmetric <b>-B3060</b>

CCT
2700K, 90 CRI <b>-T27</b>
3000K, 90 CRI <b>-T30</b>
3500K, 90 CRI <b>-T35</b>
4000K, 90 CRI <b>-T40</b>

#### Options

Louver	<b>-LVR</b>
Soft Focus Lens	<b>-SFL</b>
Red Filter	<b>-ML39</b>
Yellow Filter	<b>-ML40</b>
Blue Filter	<b>-ML41</b>
Amber Filter	<b>-ML42</b>
Green Filter	<b>-ML43</b>

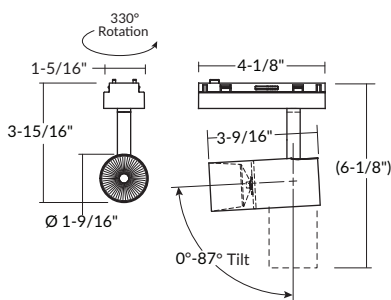

MM307

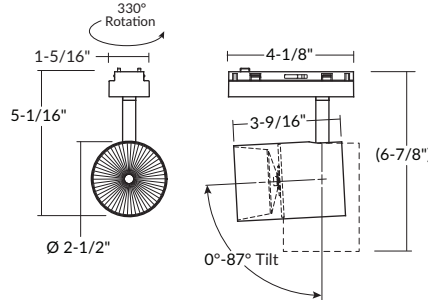

MM315

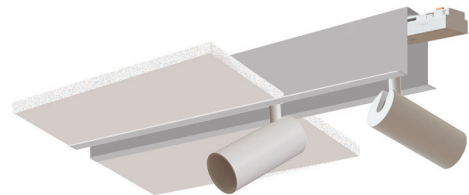

## ILLUMINATED MODULES

### MM3Q Adjustable Spot

Ordering Example: MM3QB-B20-T27

- Regressed LED optic for low glare
- Fully Adjustable

Lumens
650lm (9W) <b>MM3Q</b>

Finish
Black <b>B</b>
White <b>W</b>

Beam Spread
10° Narrow Spot <b>-B10</b>
20° Spot <b>-B20</b>
40° Flood <b>-B40</b>
30° x 60° Asymmetric <b>-B3060</b>

CCT
2700K, 90 CRI <b>-T27</b>
3000K, 90 CRI <b>-T30</b>
3500K, 90 CRI <b>-T35</b>
4000K, 90 CRI <b>-T40*</b>

Options
Louver <b>-LVR</b>
Soft Focus Lens <b>-SFL</b>
Red Filter <b>-ML39</b>
Yellow Filter <b>-ML40</b>
Blue Filter <b>-ML41</b>
Amber Filter <b>-ML42</b>
Green Filter <b>-ML43</b>

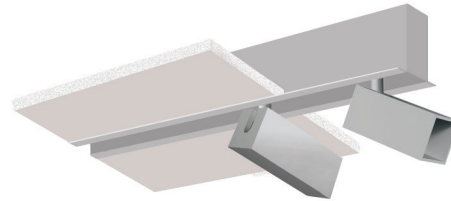
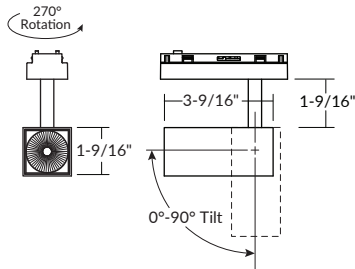

### MM1P Suspended Linear Diffused (Static White)

Ordering Example: MM1P24B-P24-L08-T27

- Pixel free illumination
- Two lumen options
- Warm dimming option
- 1000lm-4400lm

Length (L)
2' <b>MM1P24</b>
3' <b>MM1P36</b>
4' <b>MM1P48</b>

Finish
Black <b>B</b>
White <b>W</b>

Cable Length (CL)
24" Cable <b>-P24</b>
36" Cable <b>-P36</b>
48" Cable <b>-P48</b>

Lumens (Nominal Delivered)
500lm (9W) per foot <b>Blank</b>
1100lm (12W) per Foot <b>-L08</b>

CCT
2700K, 90 CRI <b>-T27</b>
3000K, 90 CRI <b>-T30</b>
3500K, 90 CRI <b>-T35</b>
4000K, 90 CRI <b>-T40</b>
Warm Dimming <b>-TWD</b>
1850K-3000K

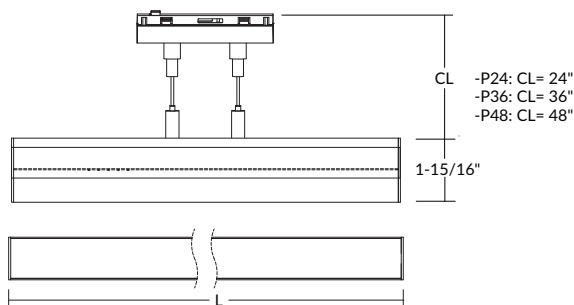

MM1P24: L = 23-3/4"  
 MM1P36: L = 35-1/2"  
 MM1P48: L = 47-3/8"

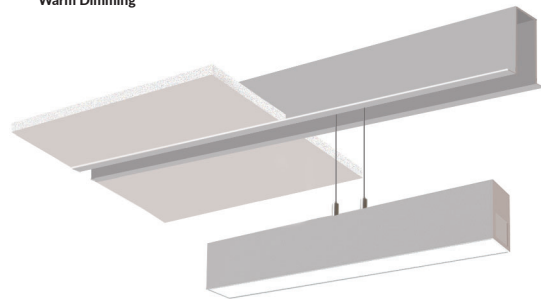

## ILLUMINATED MODULES

### MM2P Suspended Linear Louvered

Ordering Example: MM2P12B-P24-B40-T27

	Length (L)	Finish	Cable Length (CL)	Beam Spread	CCT
• Multiple beam spread options	6", 1000lm (11W) <b>MM2P06</b>	Black <b>B</b>	24" Cable <b>-P24</b>	15° Narrow Spot <b>-B15</b>	2700K, 90 CRI <b>-T27</b>
• Glare free illumination	12", 2000lm (22W) <b>MM2P12</b>	White <b>W</b>	36" Cable <b>-P36</b>	40° Flood <b>-B40</b>	3000K, 90 CRI <b>-T30</b>
• Minimal 1" square	18", 3000lm (33W) <b>MM2P18</b>		48" Cable <b>-P48</b>	60° Wide Flood <b>-B60</b>	3500K, 90 CRI <b>-T35</b>
• California Title 24/JA8 Approved				30° x 60° Asymmetric <b>-B3060</b>	4000K, 90 CRI <b>-T40</b>

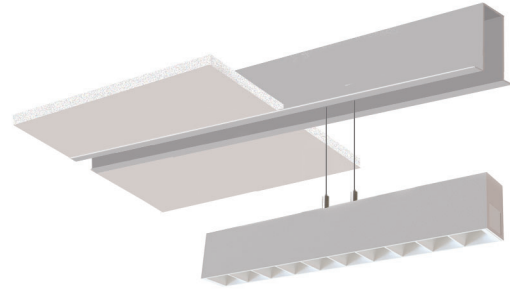
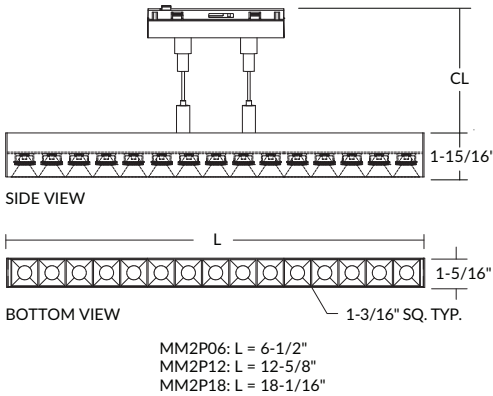

### MM4 Pendant Spot

Ordering Example: MM407B-B20-T27

	Lumens	Finish	Beam Spread	CCT
• Adjustable metallic cord	650lm (7W) <b>MM407</b>	Black <b>B</b>	10° Narrow Spot <b>-B10</b>	2700K, 90 CRI <b>-T27</b>
• Regressed LED for low glare		White <b>W</b>	20° Spot <b>-B20</b>	3000K, 90 CRI <b>-T30</b>
			40° Flood <b>-B40</b>	3500K, 90 CRI <b>-T35</b>
				4000K, 90 CRI <b>-T40</b>

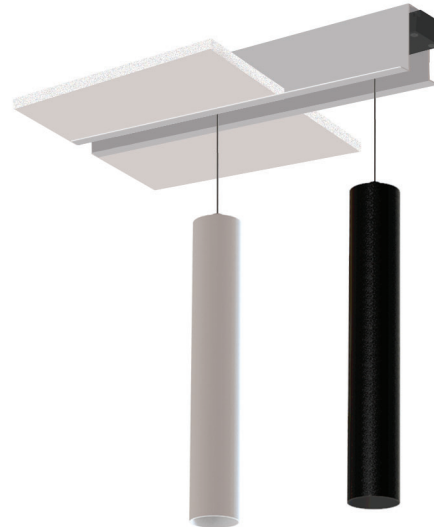
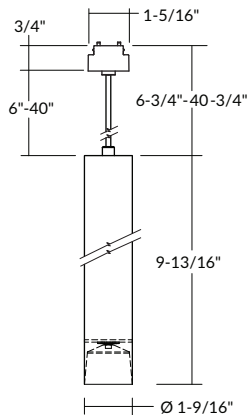



## ILLUMINATED MODULES

### MM6BL Frosted Globe (RGB +W)

Ordering Example: MM6BL-RGBW-BT

- |  |                                      |   |
|--|--------------------------------------|---|
| <ul style="list-style-type: none"> <li>• Bluetooth or DMX compatability</li> <li>• 1 million plus colors available</li> <li>• Achieve Pastel colors</li> </ul> | <b>Size</b><br>12" Dia. <b>MM6BL</b> | <b>Dimming</b><br>Basic Bluetooth Control <b>-RGBW-BT</b> |
|  |                                      | Hardwire PWM Dimming <b>-RGBW-PWM</b>                     |

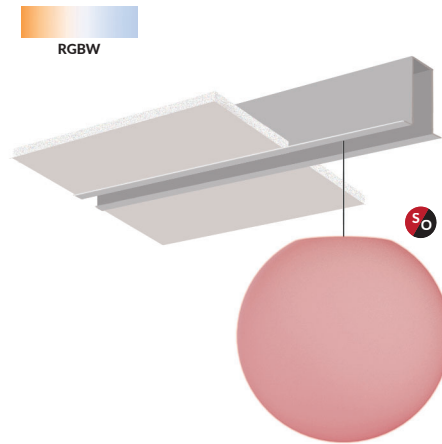
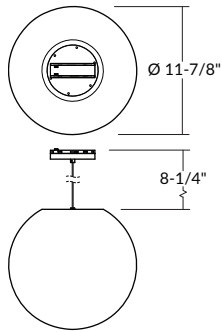

**NOTE: MM6BL Frosted Globe is not compatible with DALI.**

### MM6PD LumenPad Pendant

Ordering Example: MM6PD12W-12-T27

- |  |   |   |   |  |  |
|--|---|---|---|--|--|
| <ul style="list-style-type: none"> <li>• 90 CRI Color Rendering Index</li> <li>• Polycarbonate Frosted White Lens</li> </ul> | <b>Fixture</b><br>LumenPad Pendant 24VDC <b>MM6PD</b> | <b>Size (DIA.)</b><br>5", 1000lm (11W) <b>05</b><br>7", 1300lm (14W) <b>07</b><br>12", 2000lm (22W) <b>12</b> | <b>Finish</b><br>Black <b>B</b><br>White <b>W</b> | <b>Cord Length</b><br>12" <b>-12</b><br>24" <b>-24</b><br>36" <b>-36</b><br>48" <b>-48</b><br>60" <b>-60</b><br>72" <b>-72</b> | <b>CCT</b><br>2700K, 90 CRI <b>-T27</b><br>3000K, 90 CRI <b>-T30</b><br>3500K, 90 CRI <b>-T35</b><br>4000K, 90 CRI <b>-T40</b> |
|--|---|---|---|--|--|

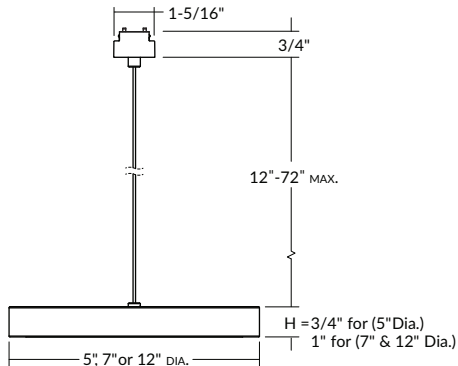

Special order item. Extended lead time.

## ILLUMINATED MODULES

### MMEXT Exit Signage

Ordering Example: MMEXT00-1B

- Maintenance free
- No lamps or batteries
- No wiring needed
- 25-year life expectancy

**Fixture**  
 Self-Luminescent Exit Sign **MMEXT**

**Length**  
 No Stem **00**  
 12" Stem **12\***  
 24" Stem **24\***  
 36" Stem **36\***  
 48" Stem **48\***

**Single/Double**  
 Single Side **-1**  
 Double Sided **-2**

**Finish**  
 Black **B**  
 White **W**

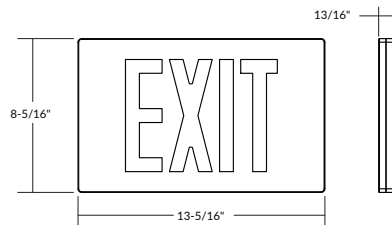

 Special order item. Extended lead time.

**DIGITAL DEVICES**

**MPD-USB**  
 4A 5V USB Adapter  
 (Max 20W)

Allows for power of digital devices such as Wireless Cameras, Routers, Speakers and other 5V Elements

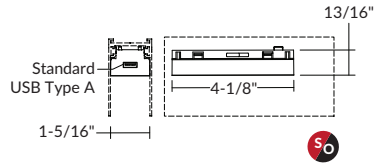

**MPD-SOCC**  
 60W Occupancy Sensor

Turns ModuLED system off/on based on human presence in room.

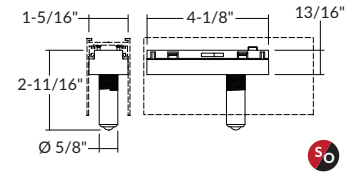

**24V POWER SUPPLIES**

**Universal Dimming**

Model	Description	Input Voltage	Wattage	Dimming	Listing	DIMENSIONS (in.)
LD533V024-1227-60-DUN-JB	60W 5-Wire Power Supply	120V/277V	60W	0-10V/Triac/ELV	UL, cUL Listed	7.4" x 3.7" x 1.6"
LD533V024-1227-96-DUN-JB	96W 5-Wire Power Supply	120V/277V	96W	0-10V/Triac/ELV	UL, cUL Listed	8.6" x 3.7" x 1.6"
LD533V024-1227-200-DUN-JB	200W 5-Wire Power Supply	120V/277V	200W	0-10V/Triac/ELV	UL, cUL Listed	10.2" x 3.7" x 1.6"

**DALI Dimming**

Model	Description	Input Voltage	Wattage	Dimming	Listing	DIMENSIONS (in.)
LD533V024-96-DLI-JB	96W 0.1% DALI Power Supply	120V/277V	96W	DALI	UL Listed	9.6" x 2.5" x 1.2"

**Lutron Dimming**

Model	Description	Input Voltage	Wattage	Dimming	Listing	DIMENSIONS (in.)
LD533V024-1227-96-L3DOE	Hi-Lume Premier 0.1% EcoSystem 24V constant voltage LED driver with Soft-on, Fade-to-Black dimming technology	120V/277V	96W	PWM	UL, cUL Listed	10.5" x 5.5" x 2.0"

**Non-Dimming**

Model	Description	Input Voltage	Wattage	Dimming	Listing	DIMENSIONS (in.)
LD533V024-1227-240	240W Non-Dimming Power Supply	120V/277V	240W	Non-Dimming	UL Listed	8.6" x 2.7" x 1.5"

 Special order item. Extended lead time.

**DRIVER DIMMER COMPATABILITY LIST (DIN) Power Supply**

Brand	Model	Input	Range	Model	Input	Range	
	153PR-WH	100-130V	0-100%	DZ6HD	100-130V	22-100%	
	DVCL-153P	100-130V	0-100%	DV-600PR-BL	100-130V	0-100%	
	DVWCL-153PH-LA	100-130V	0-100%	DV-600PR-WH	100-130V	0-100%	
	CTCL-153PDH-LA	100-130V	0-100%	PD-6WCL	100-130V	20-100%	
	TGCL-153PR-WH	100-130V	0-100%	PD-5NE-WH	100-130V	18-100%	
	TGCL-153PH-WH	100-130V	0-100%	NTLV-600-277-WH	100-130V	1-100%	
	MACL-153MH-LA	100-130V	20-100%	ST-12P-277	100-130V	12-100%	
	CT-600PR-IV	100-130V	0-100%	NTF-10-277	100-130V	1-100%	
	CT-600PR-WH	100-130V	0-100%	SELV-300P	100-130V	15-100%	
	CT-103PR-WH	100-130V	2-100%	MSCELV-600M	100-130V	0-100%	
	MIR-600M	100-130V	2-100%	MEF2-6ELV-120	100-130V	0-100%	
	TG-600PR-LA	100-130V	4-100%	DVELV-300P	100-130V	15-100%	
	TG-600PR-IV	100-130V	0-100%	S-600PR-WH	100-130V	0-100%	
	TG-600PR-WH	100-130V	0-100%	MRF2-6ND-120-AL	100-130V	0-100%	
	TG-10PR-WH	100-130V	0-100%	MRF2-6CL-GR	100-130V	15-100%	
		VPI06-1LZ	100-130V	15-100%	6672	100-130V	20-100%
		TTI06-1LZ	100-130V	1-100%	6683	100-130V	10-100%
		IPL06	100-130V	15-100%	6602	100-130V	0-100%
DZ6HD		100-130V	17-100%	AWSMT-EAW	100-130V	0-100%	
TBL03		100-130V	15-100%	AWSMT-EAW	277V	0-100%	
6674		100-130V	16-100%				
	RHCL453PNICCV6	100-130V	6-100%				
	WSCL450TCCCV4	100-130V	11-100%				
	LSCL453PLACCV4	100-130V	11-100%				
	CLW-DELVEX-P-W-S	100-130V	11-100%				